

FORMAX®

HERE BEGINS YOUR ULTIMATE VALUE

FGS-LQ Series
Gravimetric
Liquid Color

FGS-LQ-CT

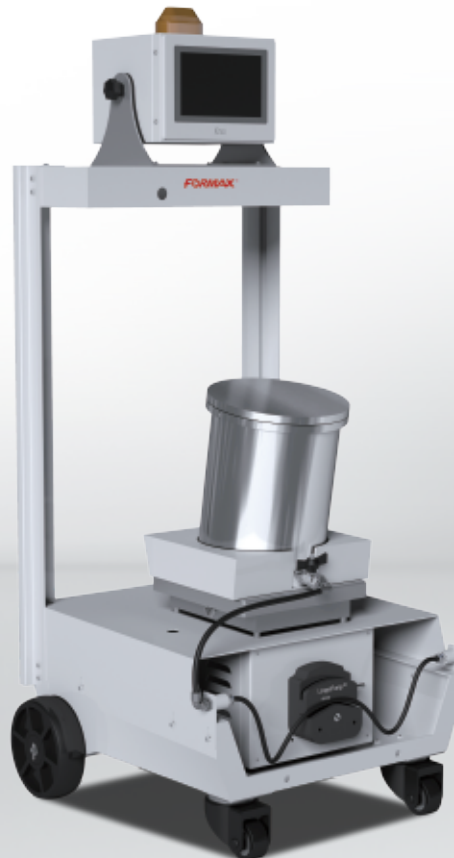

Please read the brochure carefully before operation.

FGS-LQ Series Gravimetric Liquid Color

■ Coding Principle

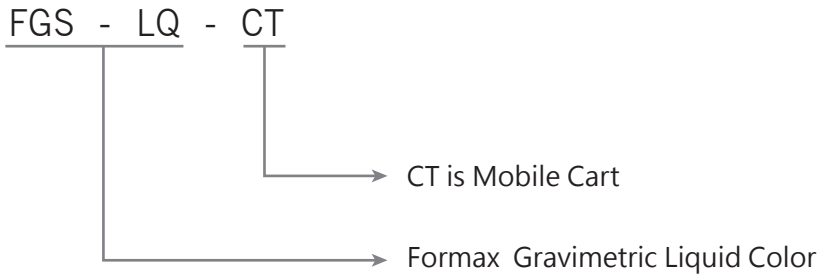

FGS-LQ

■ Features

- User-friendly control design, color touch screen, easy to use
- Widely usable, it can be used from low viscosity to high viscosity liquid color
- High precision, the highest measurement accuracy can reach ± 0.1
- No contamination, the liquid only touches the pump tubing
- Easy to clean, just change the hose when changing color.
- Easy maintenance, no seals, no valve.

■ Working Principle

Very accurate proportional system, no need to calibrate and compensate for material density, mixing the liquid color and raw materials through the discharge port of the injection molding machine screw for obtaining the desired product.

■ Peristaltic Pump Head

Peristaltic pump head classic design, easy to operate and widely used, pump head housing with PESU material, excellent structural performance, Stainless steel of one piece bearing, strong chemical resistance, stable performance.

- The pump uses stainless steel roller for high strength and precision.
- The hose changing mechanism adopts a quick separation structure, and the hose change is quick and convenient.
- Suitable for a variety of hoses, Wide flow range.



| Model | Qty' of Roller | Roller Material | Housing Material | Speed Range (rpm) | Suitable Hoses | Maximum flow range (ml/min) | Weight (kg) |
|---------|----------------|-----------------|------------------|-------------------|------------------------|-----------------------------|-------------|
| 1515X-A | 3 | Stainless steel | PESU | ≤ 600 | 14#19#16# 25#17#18# | 2200 | 0.4 |
| 1515X-B | 6 | | | | | 1450 | |

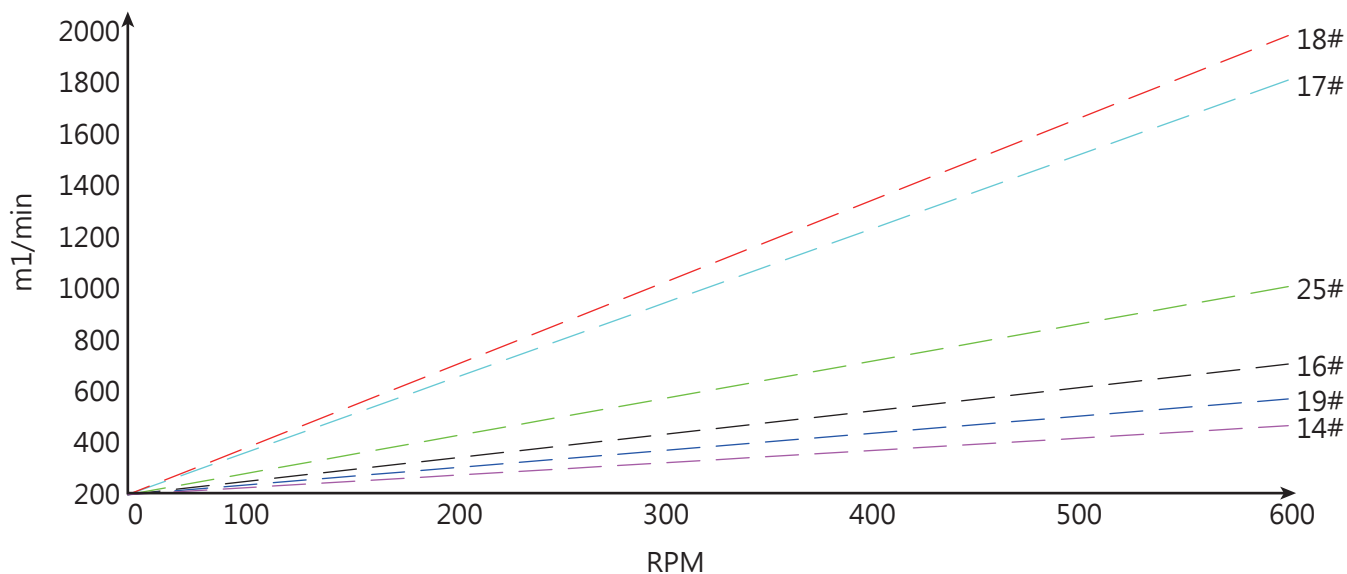

■ Peristaltic Pump Head

Three different hose types are available depending on the speed of the peristaltic pump

- Red - - - - - #25
- Blue - - - - - #17
- Black - - - - - #16

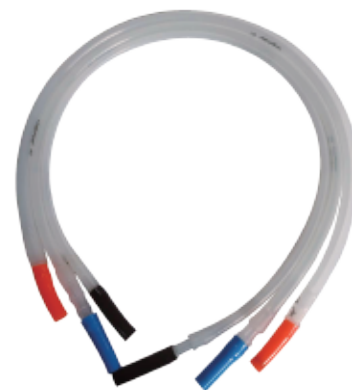

■ Injection Nozzle and Mixer (optional)

Injection nozzle for connection between pump outlet and injection machine, composed of injection unit and feeding plate



Injection Nozzle

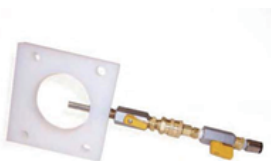

Injection Nozzle and Feeding Plate



Mixer

■ Outline Drawings

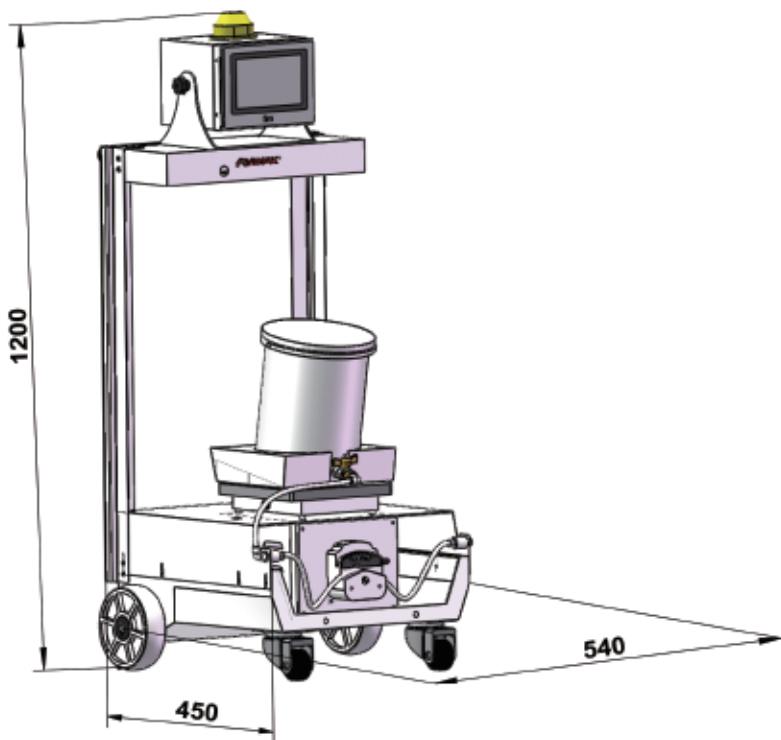

FGS-LQ-CT

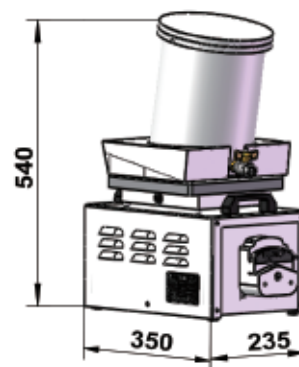

FGS-LQ

FORMAX[®]

China
Formax Plastics Automation, Inc.

Dongguan
 Xianxi New Industrial Zone, Xianxi Community,
 Changan Town, Dongguan, Guangdong, China
 Tel. +86-769-3899-9898 Fax. +86-769-8533-3467

Kushan
 No.138-20, Hengshan Road, Kunshan, Jiangsu, China
 Tel. +86-512-5700-8308 Fax. +86-512-5700-8306

Taiwan
Formax Equipment Inc.

7F-1, No.265, NanKang Road, Luchu Dist.,
 Taoyuan City, Taiwan
 Tel. +886-3-2121-725 Fax. +886-3-2127-960

www.formax88.com
www.formaxpa.com



All rights reserved.